

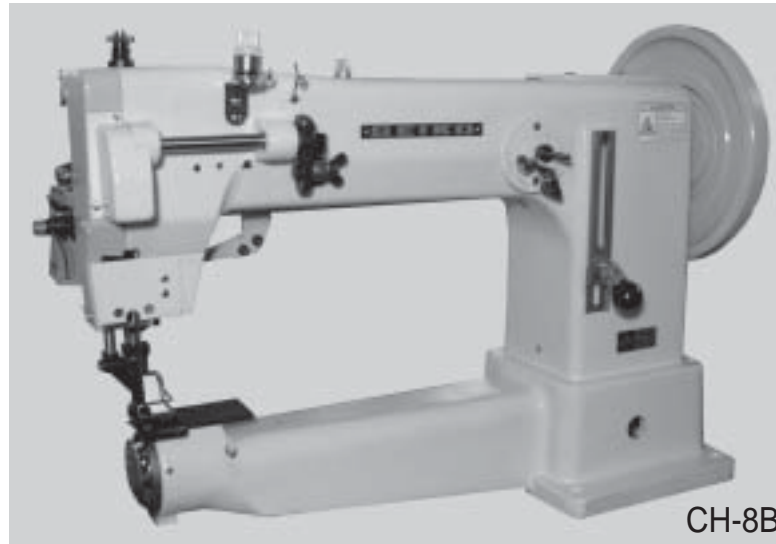





# CH series

Single needle, Extra heavy duty, Large oscillating shuttle hook, Long arm, Cylinder bed, Lockstitch machines



CH-8B

## Variety

- 
**CH-2B**  
 Drop feed and walking foot, reverse stitch
- 
**CH-2/RF**  
 Drop feed and walking foot  
 (Capable of intermittent shirring)
- 
**CH-6B**  
 Drop feed, reverse stitch
- 
**CH-7B**  
 Compound feed, reverse stitch
- 
**CH-8B**  
 Compound feed and walking foot, reverse stitch
- 
**CH-8BV**  
 Compound feed and walking foot, reverse stitch,  
 vibrating binder



CH-2B



Sewing heavy thick leather sheets by CH-2B

## Applications

For sewing heavy weight materials such as canvas, vinyl, leather, synthetics and various coated, laminated and rubberized fabrics

Suitable for sewing tubular and curved work, etc.



## Features

Maximum stitch length 25/64"(10 mm)

\* Maximum stitch length(forward&reverse)in this series is an extremely long of 10mm and will give a remarkable effect in sewing for heavy materials which require coarse stitches.

Long arm

\* Long arm (working space 400 mm) makes it easier to sewing works for large sized materials.

\* In addition, attachments on the machine can easily be exchanged.

Large hook

\* As the machine implies a large hook, the winding volume of the lower thread is increased.

\* Thus, the working efficiency is remarkably enhanced in the sewing for extra heavy materials and long stitch length, due to saving the time of the lower thread replacement. Further, this is the mechanism which can be attained a beautiful stitching.

High presser lift

\* Presser lift 20 mm by knee lifter suits for the sewing of extra heavy materials.

Great reliability

\* Each component parts and mechanisms are planned, selected the materials thoroughly and produced considering the durability and sewability for the heavy weight materials, without any troubles.

\* You will be able to satisfy the sewing in the long time.

Substantial CH series

\* Substantial varieties (with reverse feed respectively) which are installed with needle • upper & lower, needle & lower feed, lower feed, and upper & lower feed (Capable of intermediate shirring) will meet to the various kinds of sewing needs. A cloth plate for flat work can be supplied as an optional extra. Belt guard (Optional) is available.

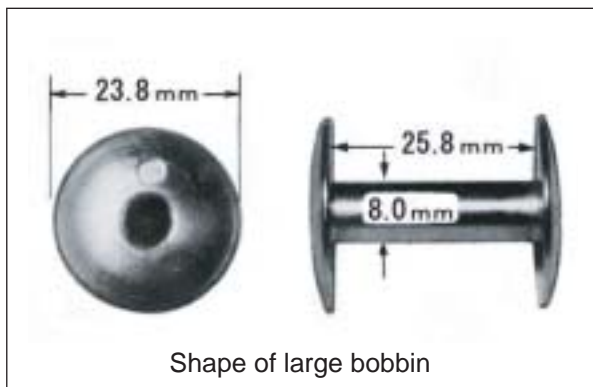

By adoption of large hook, the winding volume of lower thread is increased and due to this feature, the frequency of lower thread replacement is minimized.



The practical use of wide working space(200 × 400), high presser lift amount (20mm by knee lifter) and large hook make it possible wide application for heavy weight materials.



CH-6B



CH-6B Standard : Roller foot

## CH-6B (Drop feed, reverse stitch)

Wider range works, such as taping, etc. can be done by attachments. Further, the machine makes it easy to handle the materials. (Standard : Roller foot. Flat foot is available.)



## CH-7B (Compound feed, reverse stitch)

Compound feed will give a remarkable effect in sewing for heavy materials.

## CH-8B (Compound feed and walking foot, reverse stitch)

Powerful and accurate feed mechanism combined with compound feed and walking foot have enhanced the sewability for heavy materials.

Equipped with the special gauge (optional) which has exclusively been developed by SEIKO, the sewing of the hard materials or corner sector, such as suit cases, instrumental cases, will give an attractive effect. Thus, the value of goods can greatly be heightened up.

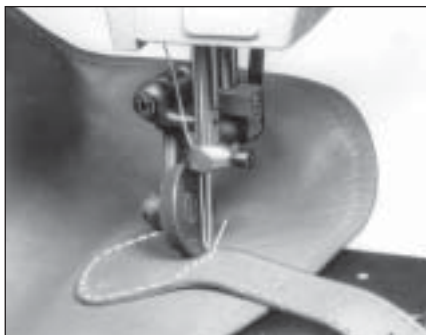

Sewing bag handle  
by CH-6B



Sewing heavy thick canvas sheets  
by CH-7B

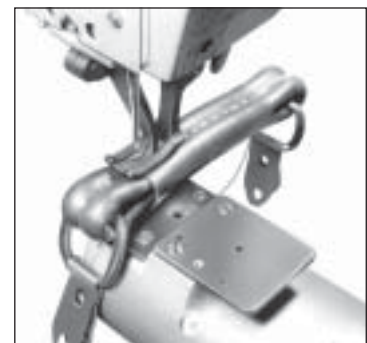

Sewing heavy thick bag handle  
by CH-8B of special specifications

## CH-2/RF (Drop feed and walking foot / capable of differential feed)

This is the machine for heavy duty sewing, which is capable of intermediate ruffling works as desired by changing the amount of upper feeding against lower feeding, in addition to usual plain sewing works synchronized upper & lower feed.

- Features
- \* Amount of feeding ratio between upper feed and lower feed can easily be changed by pulling down the lifting lever which chained with treading foot pedal or knee works/motor work even during sewing operation which is obtainable intermediate ruffling stitches.
  - \* Wide working space makes it easier to handle the bulky materials being sewn.
  - \* Acceptable common attachments for special stitching.
  - \* Various kinds of ruffling or open edge moccasin stitches can be performed.



## CH-8BV (Compound feed and walking foot, reverse stitch, with binder / vibrating type)

- Features
- \* Binder is vibrating type and due to this feature, a beautiful tape binding finish for heavy materials or elastic tape can smoothly and easily be performed.
  - \* Various kinds of binders are provided with your requirements.

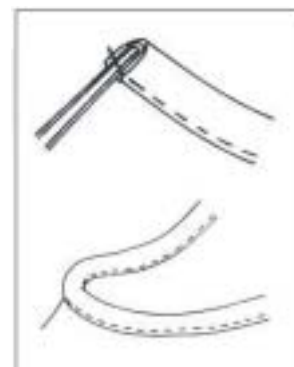
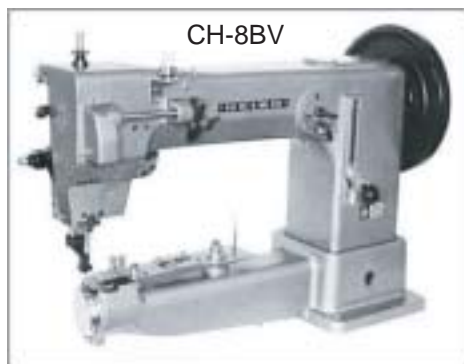

### Specifications (CH- )

Variety		2 / RF	2B	6B	7B	8B	8BV
Number of needle		Single needle					
Max. sewing speed		700 s.p.m.	800 s.p.m.				700 s.p.m.
Max. stitch length		15/64"(6 mm) Upper 15/32"(12 mm) Lower	25/64" (10 mm)				9/32" (7 mm)
Clearance under presser foot	by knee	15/32" (12 mm)	63/64"(25 mm)	25/32" (20 mm)		63/64"(25 mm)	3/4"(19 mm)
	by hand	5/16" (8 mm)	25/64"(10 mm)	25/64"(10 mm)		25/64"(10 mm)	5/16"(8 mm)
Needle bar stroke		2" (51 mm)	2-13/64"(56 mm)	2" (51 mm)		2-13/64"(56 mm)	
Needle(standard)		DYx3 (#24) 794(#180)		DDx1(#25) 328(#200)	DDx1(#24) 328(#180)	DYx3 (#24) 794(#180)	
Hook		Shuttle hook					
Amount of lift of walking foot		1/8"-15/64" standard 5/32" (3 - 6 mm) (standard 4 mm)			1/8"-15/64" standard 5/32" (3 - 6 mm) (standard 4 mm)		
Thread take up lever		Cam type					
Lubrication		Hand type					
Bed size		23-5/8"x 3-15/64" (600 x 82 mm)					
Cylinder size		3-15/64" (82 mm) dia.					
Working space		15-3/4"x 7-7/8" (400 x 200 mm)					
Motor		Clutch motor					

NOTE (1) Speed depends on threads, materials and type of operation  
 (2) Specifications subject to change without notice



### SEIKO SEWING MACHINE CO., LTD.

2-13-6, Sakaecho, Funabashi-shi  
 Chiba Prefecture, 273-0018, Japan

Phone : +81-47-420-3561 (Overseas dept.)

Fax : +81-47-420-3560

E-mail : export@seiko-sewing.co.jp

<http://www.seiko-sewing.co.jp/>